

GEOGRAPHY

2217/23

Paper 2

October/November 2015

INSERT

2 hours 15 minutes

READ THESE INSTRUCTIONS FIRST

This Insert contains Photograph A for Question 2, Photograph B for Question 4, Photograph C, Table 3 and Figs 10 and 11 for Question 7, and Tables 4 and 5 and Figs 13 and 17 for Question 8.

The Insert is **not** required by the Examiner.



This document consists of **9** printed pages and **3** blank pages.

Photograph A for Question 2



Photograph B for Question 4



H

Photograph C for Question 7



Fig. 10 for Question 7

Measuring equipment

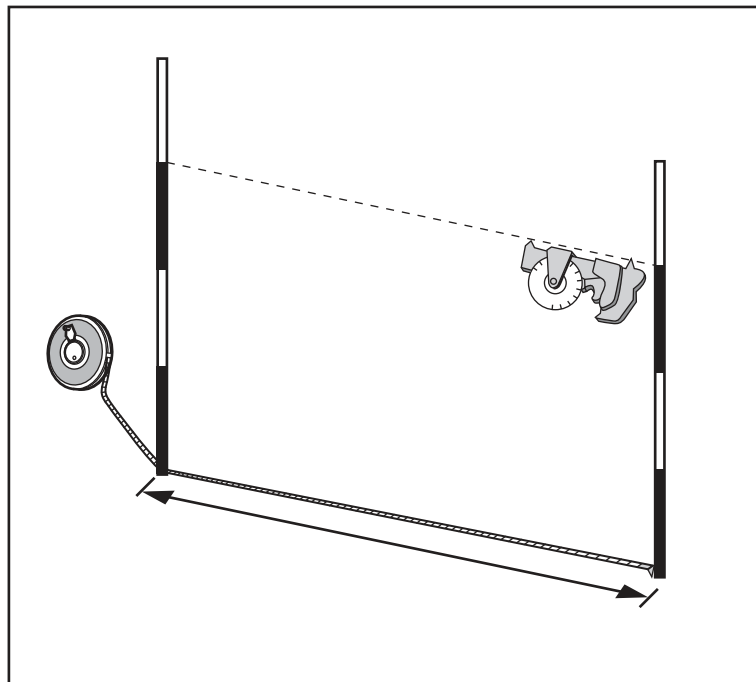

Fig. 11 for Question 7

Transect profile across sand dunes

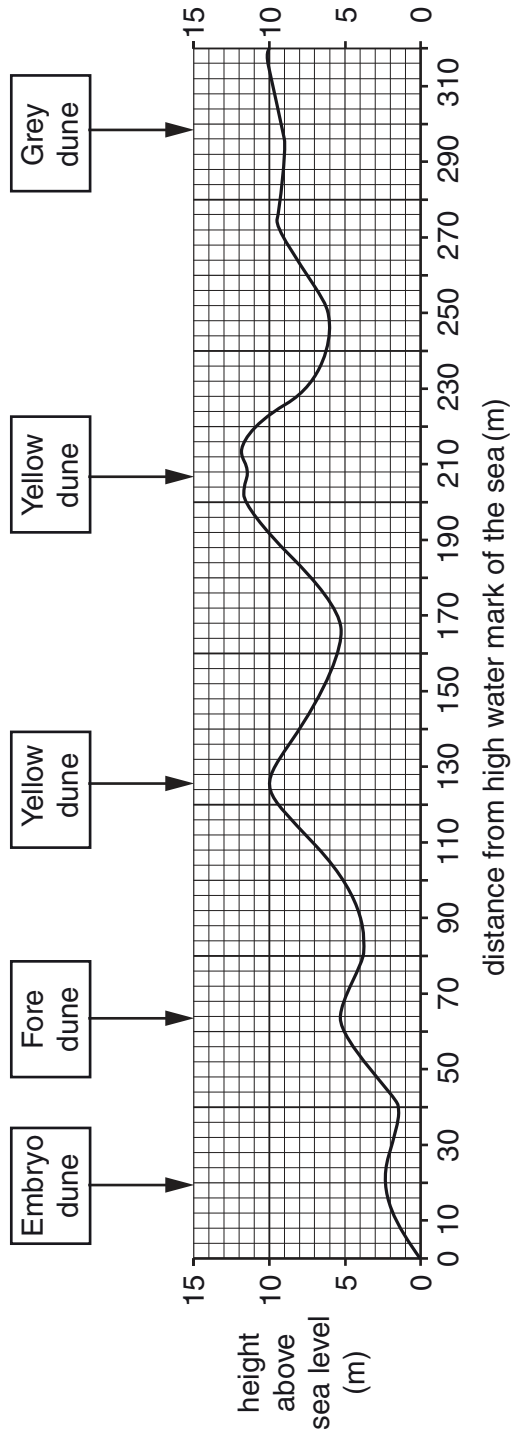

Table 3 for Question 7

Students' fieldwork results



Site along transect	Distance from high water mark of sea (m)	Amount of vegetation cover (%)	Main type of vegetation
1	10	20	Sea couch grass
2	30	30	Sea lyme grass
3	50	25	Marram grass
4	70	40	Marram grass
5	90	50	Rosette plants
6	110	55	Marram grass
7	130	50	Marram grass
8	150	60	Marram grass
9	170	55	Rosette plants
10	190	60	Marram grass
11	210	75	Brambles
12	230	60	Marsh plants
13	250	70	Marsh plants
14	270	90	Gorse
15	290	95	Heather
16	310	85	Heather

Fig. 13 for Question 8

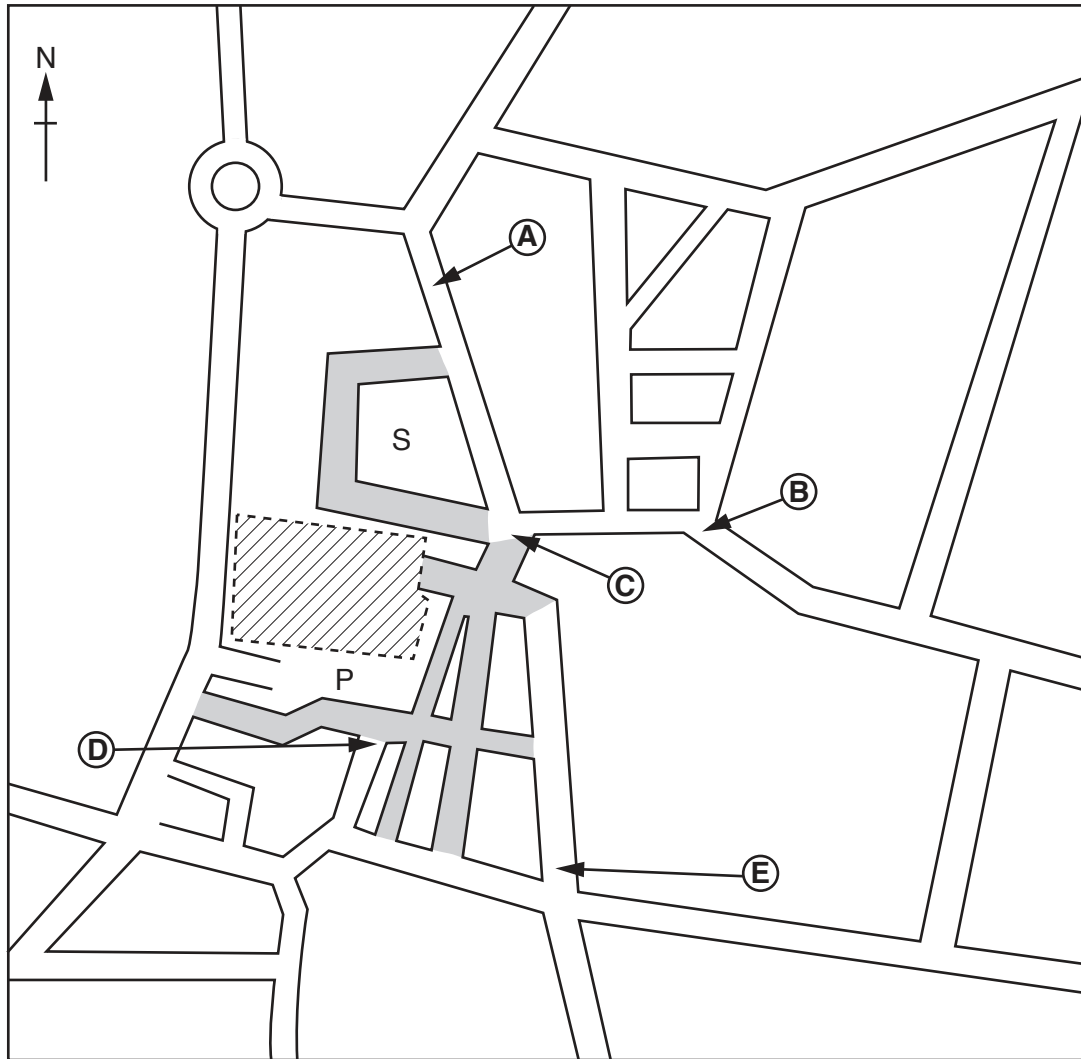
Location of the new shop in the CBD



Key

-  new shop
- P shop car park
- S indoor shopping area
-  restricted access for vehicles
-  location of survey points

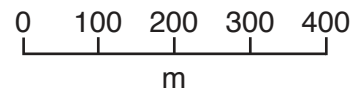

Table 4 for Question 8

Results of the questionnaire

Statement	Agree strongly	Agree	Disagree	Disagree strongly
The shop has brought a larger variety of goods and services to the town centre.	38	26	33	3
The shop attracts people to come to the town centre more often.	31	40	20	9
The shop has provided more jobs in the town centre.	57	37	3	3
The shop has meant increased competition for other shops in the town centre.	24	25	37	14

Fig. 17 for Question 8

Environmental quality recording sheet

Environmental quality survey							
Location: Area A/B/C/D/E (circle the area)							
Feature	Negative description	1	2	3	4	5	Positive description
Building layout and design	Poorly laid out, unattractive appearance						Well laid out, attractive appearance
Building care and condition	Poorly maintained						Well maintained
Pavements	No pavement or poorly maintained						Well maintained and safe to walk on
Traffic	Lots of traffic causing congestion and queues						Very little traffic moving freely or pedestrianised
Public open space	None, unattractive natural environment						Plenty of public open space and attractive natural environment
Noise	Very noisy from different sources						Quiet and causes no inconvenience
General appearance	Widespread litter, graffiti, damage						No litter, graffiti, damage

Table 5 for Question 8

Results of survey

Feature	Survey point				
	A	B	C	D	E
Building layout and design	3	2	4	5	3
Building care and condition	4	2	4	5	3
Pavements	4	2	4	4	3
Traffic	3	3	5	4	2
Public open space	3	1	4	5	2
Noise	2	2	3	3	2
General appearance	3	2	3	4	2
Total score	22	14	27	30	17

BLANK PAGE

Permission to reproduce items where third-party owned material protected by copyright is included has been sought and cleared where possible. Every reasonable effort has been made by the publisher (UCLES) to trace copyright holders, but if any items requiring clearance have unwittingly been included, the publisher will be pleased to make amends at the earliest possible opportunity.

To avoid the issue of disclosure of answer-related information to candidates, all copyright acknowledgements are reproduced online in the Cambridge International Examinations Copyright Acknowledgements Booklet. This is produced for each series of examinations and is freely available to download at www.cie.org.uk after the live examination series.

Cambridge International Examinations is part of the Cambridge Assessment Group. Cambridge Assessment is the brand name of University of Cambridge Local Examinations Syndicate (UCLES), which is itself a department of the University of Cambridge.